

## Surface Mount Schottky Rectifier

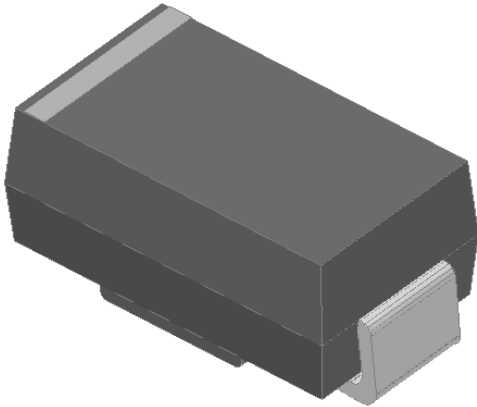

### Features

- Low profile package
- Ideal for automated placement
- Guardring for overvoltage protection
- Low power losses, high efficiency
- High forward surge capability
- Meets MSL level 1, per J-STD-020, LF maximum peak of 260 °C
- Part no. with suffix "Q" means AEC-Q101 qualified

### Typical Applications

For use in low voltage high frequency inverters, freewheeling, DC/DC converters, automotive and polarity protection applications.

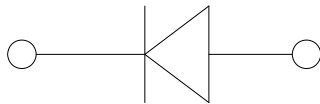

### Mechanical Data

- **Package:** DO-214AC (SMA)  
Molding compound meets UL 94 V-0 flammability rating, RoHS-compliant, halogen-free
- **Terminals:** Tin plated leads, solderable per J-STD-002 and JESD22-B102
- **Polarity:** Cathode line denotes the cathode end

### ■ Maximum Ratings ( $T_a=25^\circ\text{C}$ Unless otherwise specified)

| PARAMETER  | SYMBOL    | UNIT             | SS32AQ    | SS33AQ | SS34AQ |
|--|-----------|------------------|-----------|--------|--------|
| Device marking code  |           |                  | SS32A     | SS33A  | SS34A  |
| Repetitive peak reverse voltage  | $V_{RRM}$ | V                | 20        | 30     | 40     |
| Maximum RMS voltage  | $V_{RMS}$ | V                | 14        | 21     | 28     |
| Maximum DC blocking voltage  | $V_{DC}$  | V                | 20        | 30     | 40     |
| Maximum average forward rectified current at $T_L$ (Fig.1)                                 | $I_O$     | A                | 3.0       |        |        |
| Surge(non-repetitive)forward current @60Hz half-sine wave, 1 cycle, $T_J=25^\circ\text{C}$ | $I_{FSM}$ | A                | 80        |        |        |
| Voltage rate of change (rated $V_R$ )  | $dV/dt$   | V/ $\mu\text{s}$ | 10000     |        |        |
| Storage temperature  | $T_{stg}$ | $^\circ\text{C}$ | -55 ~+150 |        |        |
| Junction temperature   | $T_J$     | $^\circ\text{C}$ | -55 ~+150 |        |        |

### ■ Electrical Characteristics ( $T_a=25^\circ\text{C}$ Unless otherwise specified)

| PARAMETER                     | SYMBOL | TEST CONDITIONS         |                         | TYP  | MAX  | UNIT          |
|-------------------------------|--------|-------------------------|-------------------------|------|------|---------------|
| Instantaneous forward voltage | $V_F$  | $I_F=3A$                | $T_J=25^\circ\text{C}$  | 0.48 | 0.5  | V             |
|                               |        |                         | $T_J=125^\circ\text{C}$ | 0.41 | 0.45 |               |
| Reverse current               | $I_R$  | Rated $V_R$             | $T_J=25^\circ\text{C}$  | 15   | 100  | $\mu\text{A}$ |
|                               |        |                         | $T_J=125^\circ\text{C}$ | -    | 30   | mA            |
| Typical junction capacitance  | $C_J$  | $V_R=4V, f=1\text{MHz}$ |                         | 150  | -    | pF            |



# SS32AQ THRU SS34AQ

## ■ Thermal Characteristics ( $T_a=25^\circ\text{C}$ Unless otherwise specified)

| PARAMETER          | SYMBOL           | UNIT               | SS32AQ            | SS33AQ | SS34AQ |
|--------------------|------------------|--------------------|-------------------|--------|--------|
| Thermal Resistance | $R_{\theta J-A}$ | $^\circ\text{C/W}$ | 55 <sup>(1)</sup> |        |        |
|                    | $R_{\theta J-L}$ |                    | 17 <sup>(1)</sup> |        |        |

Note

(1) Thermal resistance from junction to ambient and from junction to lead mounted on P.C.B. with 0.2" x 0.2" (5.0 mm x 5.0 mm) copper pad areas

## ■ Characteristics (Typical)

Fig.1: Forward Current Derating Curve

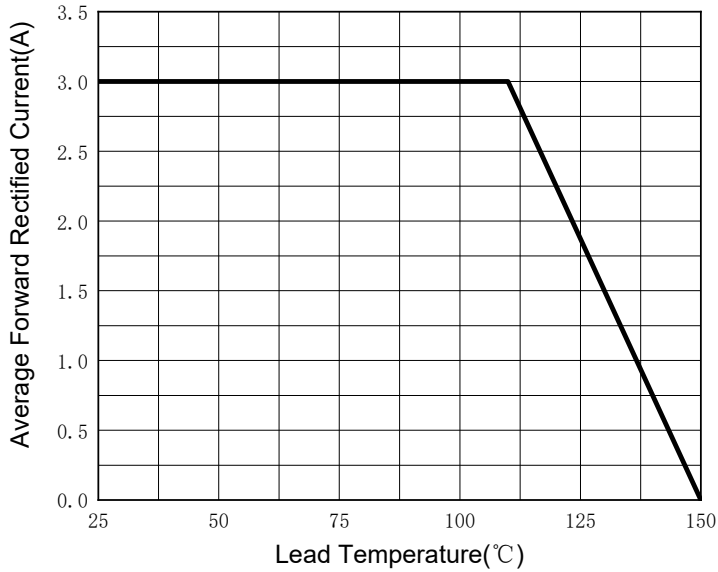

Fig.2: Maximum Non-Repetitive Peak Forward Surge Current

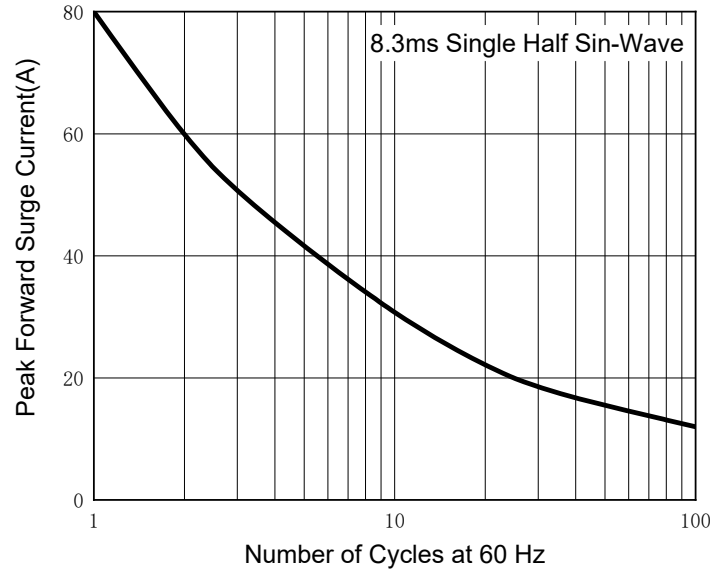

Fig.3: Typical Instantaneous Forward Characteristics

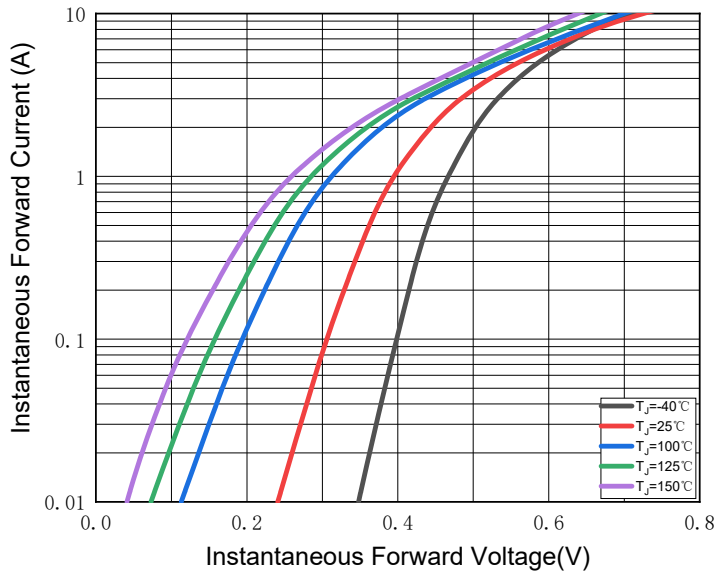
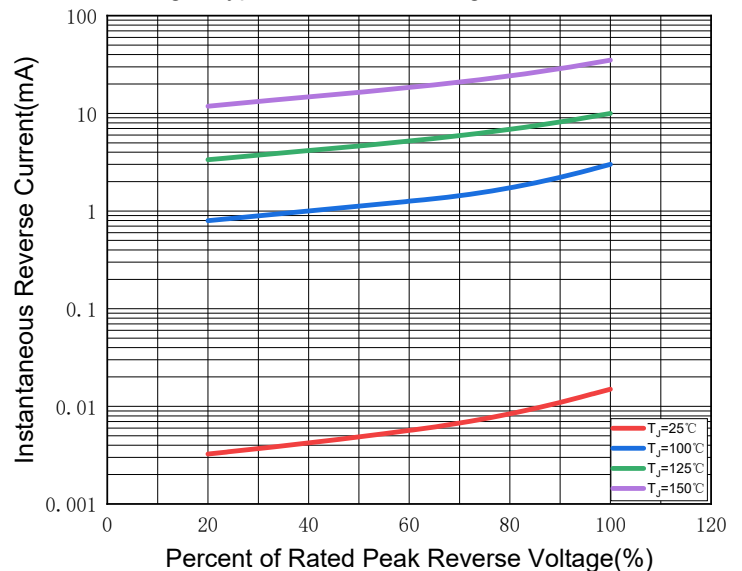

Fig.4: Typical Reverse Leakage Characteristics



## ■ Ordering Information (Example)

| PREFERRED P/N | PACKAGE CODE | UNIT WEIGHT(g)    | MINIMUM PACKAGE(pcs) | OUTER CARTON QUANTITY(pcs) | DELIVERY MODE |
|---------------|--------------|-------------------|----------------------|----------------------------|---------------|
| SS32AQ-SS34AQ | F2           | Approximate 0.067 | 7500                 | 120000                     | 13" reel      |



## SS32AQ THRU SS34AQ

### ■ Outline Dimensions

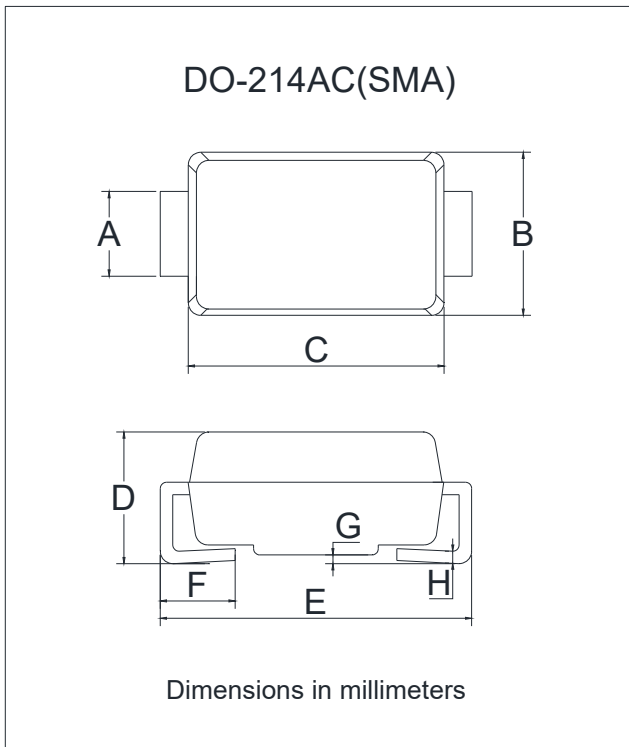

| DO-214AC(SMA) |      |      |
|---------------|------|------|
| Dim           | Min  | Max  |
| A             | 1.25 | 1.58 |
| B             | 2.40 | 2.83 |
| C             | 4.06 | 4.75 |
| D             | 1.90 | 2.30 |
| E             | 4.93 | 5.28 |
| F             | 0.76 | 1.41 |
| G             | 0.08 | 0.20 |
| H             | 0.15 | 0.31 |

### ■ Suggested Pad Layout

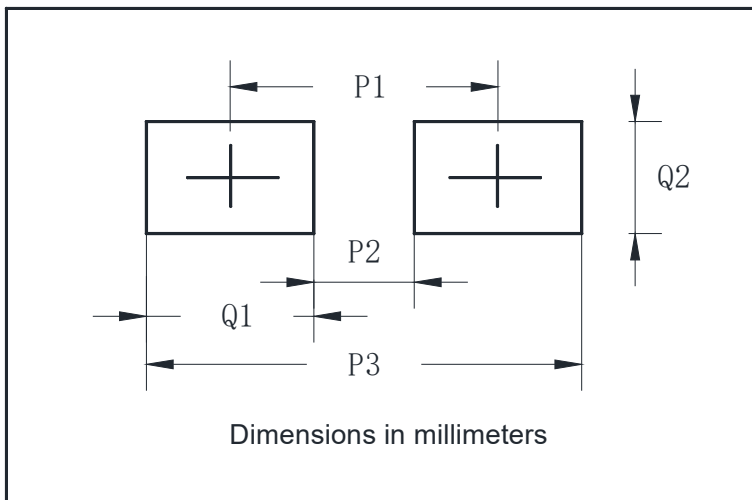

| DO-214AC(SMA) |             |
|---------------|-------------|
| Dim           | Millimeters |
| P1            | 4.00        |
| P2            | 1.50        |
| P3            | 6.50        |
| Q1            | 2.50        |
| Q2            | 1.70        |



## SS32AQ THRU SS34AQ

---

### Disclaimer

The information presented in this document is for reference only. Yangzhou Yangjie Electronic Technology Co., Ltd. reserves the right to make changes without notice for the specification of the products displayed herein to improve reliability, function or design or otherwise.

The product listed herein is designed to be used with automotive electronics, are not designed for use in medical, lifesaving, lifesustaining, or military, Yangjie or anyone on its behalf, assumes no responsibility or liability for any damages resulting from such improper use of sale.

This publication supersedes & replaces all information previously supplied. For additional information, please visit our website [http:// www.21yangjie.com](http://www.21yangjie.com) , or consult your nearest Yangjie's sales office for further assistance.